



# ELECTRONIC SCALE

MODEL 90



## SAFETY

Reloading is an enjoyable and rewarding hobby that can be conducted safely. But carelessness or negligence can make reloading hazardous. This product has been designed from the beginning with the user's safety in mind.

When reloading, safety rules must be followed. By observing these rules, the chance of a hazardous occurrence causing personal injury or property damage is minimized.

### GENERAL

- Use all equipment as the manufacturer recommends. Study the instructions carefully and become thoroughly familiar with the operation of the product. Don't take short cuts.
- Observe "good housekeeping" in the reloading area. Keep tools and components neat, clean and orderly. Promptly and completely clean up primer and powder spills.
- Reload only when you can give your undivided attention. Do not reload when fatigued or ill. Develop a reloading routine to avoid mistakes. Avoid haste – load at a leisurely pace.
- Always wear adequate eye protection. You assume unnecessary risk when reloading without wearing safety glasses.

### LOADING DATA

- Use only laboratory tested reloading data. We highly recommend the use of the SPEER Reloading Manual.
- OBSERVE ALL WARNINGS ABOUT THE USE OF MAXIMUM LISTED LOADS.

### PRIMERS AND POWDER

- Store primers and powder beyond the reach of children and away from heat, dampness, open flames and electrical equipment.
- DO NOT use primers of unknown identity. To destroy unwanted primers, soak in oil for a few days and then bury.
- Keep primers in original factory container until ready to use. Return unused primers to the same factory packaging for safety and to preserve their identity.
- DO NOT store primers in bulk. The blast of just a few hundred primers is sufficient to cause serious injury to anyone nearby.
- DO NOT force primers. Use care in handling primers.
- DO NOT use any powder unless its identity is positively known. Discard all mixed powders and those of uncertain or unknown identity.
- If you use a Powder Measure, replace the lids on both the Powder Hopper and powder can after the Powder Hopper has been filled.
- Before charging cases, settle the powder in the Powder Hopper. Throw and check the weight of at least ten charges. This will assure you that the correct powder charge is being thrown.
- After a reloading session ends, pour the remaining powder back into its original factory container. This will preserve the identity and shelf life of the powder.
- DO NOT smoke while handling powder or primers.

### RECORD KEEPING

- Keep complete records of reloads. Apply a descriptive label to each box showing the date produced, and the primer, powder and bullet used. Labels for this purpose are packed with SPEER bullets.

Since RCBS has no control over the choice of components, the manner in which they are assembled, the use of this product, or the guns in which the resulting ammunition may be used, no responsibility, either express or implied, is assumed for the use of ammunition reloaded with this product.

## ▲ WARNING

THIS SCALE IS FOR USE WITH SMOKELESS POWDERS ONLY. DO NOT USE WITH BLACK POWDER. IF BLACK POWDER SHOULD COME IN CONTACT WITH AN ELECTRICAL SPARK, AN EXPLOSION MIGHT OCCUR, CAUSING SERIOUS PERSONAL INJURY.

CHECK CALIBRATION PRIOR TO EACH USE OF THE SCALE AND RECHECK PERIODICALLY DURING USE. IF CALIBRATION ACCURACY IS FOUND TO BE OUT OF TOLERANCE, THE SCALE MUST BE RECALIBRATED AS EXPLAINED IN THE CALIBRATION SECTION OF THIS INSTRUCTION MANUAL. A SCALE WITH AN INACCURATE CALIBRATION WILL CAUSE AN INACCURATE WEIGHING, WHICH MAY EXCEED THE MAXIMUM RECOMMENDED LISTED LOAD.

ELECTRONIC SCALES ARE RELIABLE DEVICES, BUT IT IS POSSIBLE FOR FAILURES TO OCCUR THAT MAY CAUSE AN INACCURATE READING.

- CHANGES IN TEMPERATURE WILL AFFECT CALIBRATION ACCURACY. SCALES SHOULD BE ALLOWED TO STABILIZE FOR ONE HOUR PRIOR TO USE WHEN TAKEN FROM ONE LOCATION TO ANOTHER WHERE THE TEMPERATURE IS DIFFERENT.
- CHANGES IN SCALE LOCATION OR LEVEL CONDITION WILL AFFECT CALIBRATION ACCURACY.

THIS SCALE SHOULD BE SERVICED ONLY BY A TRAINED, QUALIFIED TECHNICIAN.

### PRECAUTIONS

1. USE ONLY THE CALIBRATION WEIGHTS SUPPLIED WITH THE SCALE.
2. ACCURACY OF THE WEIGHTS IS CRITICAL TO THE ACCURACY OF THE SCALE. WEIGHTS SHOULD BE KEPT CLEAN AND STORED IN A DRY PLACE. IF WEIGHTS ARE DROPPED OR DAMAGED IN ANY WAY, THEY SHOULD BE SERVICED TO VERIFY THEIR ACCURACY.
3. UNPLUG THE AC ADAPTER WHEN NOT IN USE. FOR LONG TERM STORAGE, REMOVE THE BATTERIES TO PREVENT LEAKING.
4. SET-UP SCALE PRIOR TO INTRODUCING POWDERS INTO THE AREA. DO NOT INSTALL BATTERIES IN POWDER AREA.
5. IF STATIC BUILD-UP ON SCALE IS NOTICED, WIPE SCALE WITH ANTI-STATIC TOWELETTES PROVIDED (OR ANY READILY AVAILABLE ANTI-STATIC SPRAY).
6. IF POWDER SHOULD ENTER THE UNIT, DO NOT USE THE SCALE. SEND FOR SERVICING OR CONTACT PRODUCT SERVICE.

## TABLE OF CONTENTS

**WARNING:** THIS EQUIPMENT GENERATES, USES, AND CAN RADIATE RADIO FREQUENCY ENERGY AND IF NOT INSTALLED AND USED IN ACCORDANCE WITH THE INSTRUCTION MANUAL, MAY CAUSE INTERFERENCE TO RADIO COMMUNICATIONS. IT HAS BEEN TESTED AND FOUND TO COMPLY WITH CLASS "A" REQUIREMENTS IN BOTH PART 15 OF FCC RULES AND THE RADIO INTERFERENCE REGULATION OF THE CANADIAN DOC. THIS EQUIPMENT DOES NOT EXCEED THE LIMITS FOR RADIO NOISE EMISSIONS. OPERATION OF THIS EQUIPMENT IN A RESIDENTIAL AREA MAY CAUSE UNACCEPTABLE INTERFERENCE TO RADIO AND TV RECEPTION REQUIRING THE OPERATOR TO TAKE WHATEVER STEPS ARE NECESSARY TO CORRECT THE INTERFERENCE.

LE PRÉSENT APPAREIL NUMÉRIQUE N'EMET PAS DE BRUITS RADIOÉLECTRIQUES DEPASSANT LES LIMITES APPLICABLES AUX APPAREILS NUMÉRIQUES DE CLASSE A PRESCRITES DANS LE RÈGLEMENT SUR LE BROUILLAGE RADIOÉLECTRIQUE ÉDICTÉ PAR LE MINISTÈRE DES COMMUNICATIONS DU CANADA.

<b>PREFACE</b> .....	6
<b>UNPACKING</b> .....	6
<b>INSTALLATION</b> .....	7
Power Options .....	7
Battery Installation .....	7
AC Adapter .....	8
Platform Installation .....	8
<b>TURNING THE SCALE ON</b> .....	8
<b>OPERATION</b> .....	9
Weighing .....	9
Re-zeroing .....	9
<b>CALIBRATION</b> .....	10
Checking Calibration .....	10
Calibration Procedure .....	10
<b>TROUBLESHOOTING</b> .....	12
<b>ZERO ADJUSTMENT</b> .....	13
<b>CARE AND MAINTENANCE</b> .....	14
<b>SPECIFICATIONS</b> .....	14
<b>REPLACEMENT PARTS</b> .....	14
<b>SERVICE INFORMATION</b> .....	15
<b>LIMITED WARRANTY</b> .....	15

## PREFACE

Your RCBS Electronic Scale is a precision weighing instrument that is designed to be accurate and easy to operate. This manual explains how to use your scale properly and should be read before operation.

Electronic Scales are software-controlled devices. Functions such as recalibrating the scale and zeroing are easily accomplished through the software.

## UNPACKING

Your RCBS Electronic Scale was shipped with the following items:

- a Platform
- an AC Power Adapter
- two 250-grain calibration weights
- a Scale Pan (scoop)
- antistatic towelettes
- this Instruction Manual
- your Warranty Card

Carefully unpack all of the items. It is recommended to save the packing material and carton for storing and/or transporting the scale.

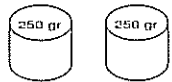

CALIBRATION WEIGHTS

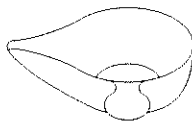

SCALE PAN (SCOOP)

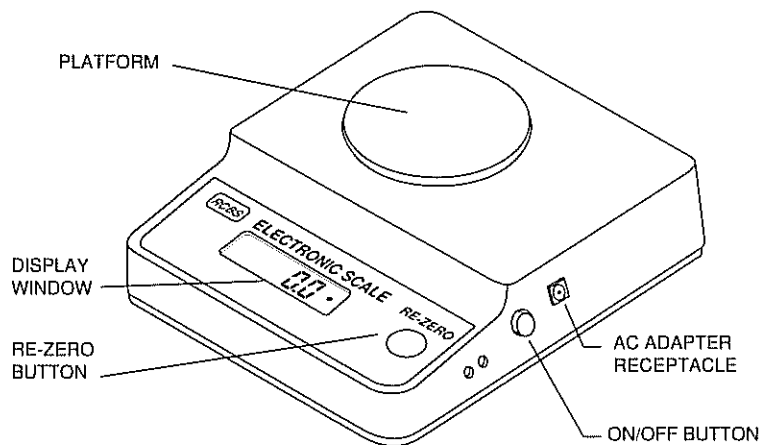

## INSTALLATION

### IMPORTANT!

Electronic scales are reliable devices, but it is possible for failures to occur that may cause an inaccurate reading.

- Changes in temperature will affect calibration accuracy. Scales should be allowed to stabilize for one hour prior to use when taken from one location to another where the temperature change is greater than a few degrees.
- Changes in scale location or level condition will affect calibration accuracy.

IT IS RECOMMENDED THAT YOU CHECK CALIBRATION PRIOR TO EACH USE OF THE SCALE AND RECHECK PERIODICALLY DURING USE. If calibration accuracy is found to be out of tolerance, the scale must be recalibrated as indicated in the Calibration section.

DO NOT install the scale:

- near open windows/doors causing drafts or rapid temperature changes.
- near air conditioning or heat vents.
- near vibrating, rotating or reciprocating equipment.
- on an unlevel work surface.

## Power Options

The scale can be operated using 8 AA Alkaline batteries (not included), or from any AC electrical outlet by using the AC Adapter supplied.

## Battery Installation

If the platform is installed, remove it to prevent damage to the scale. Batteries must be installed in the bottom of the scale as follows:

1. Press the tabs on the Battery Cover inward and lift the cover off.
2. Lift the Battery Holder out of the compartment.
3. Install the 8 AA Alkaline batteries in the Battery Holder, orienting the plus (+) and minus (-) ends as indicated on the Holder.

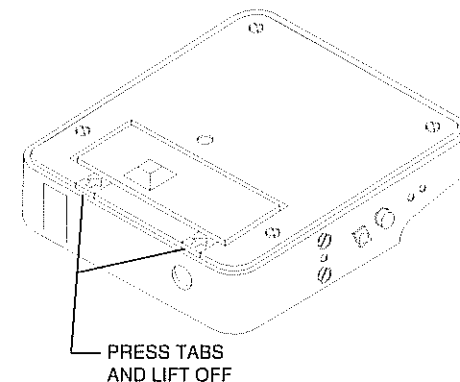

- Replace the Battery Holder in the compartment. Make sure the snap connector is connected to the Battery Holder.
- Replace the Battery Cover.

## AC Adapter

Plug the jack from the Adapter into the receptacle located on the right side of the scale. Plug the Adapter into a convenient AC outlet.

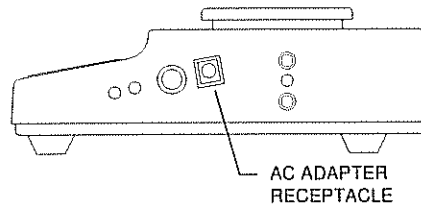

## Platform Installation

The platform must be installed on top of the scale by inserting the shaft of the platform into the hole in the weighing mechanism.

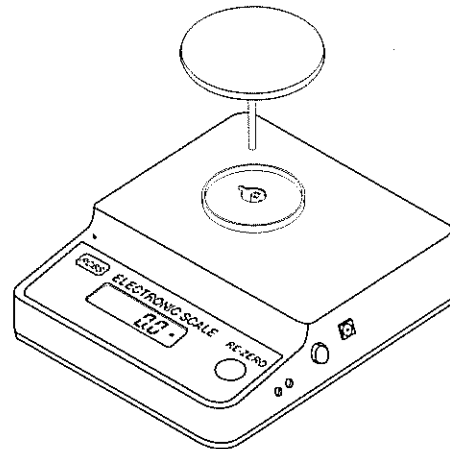

## TURNING THE SCALE ON

With no load on the scale, switch the scale ON by pressing the ON/OFF button located on the right side of the scale. When the scale is first switched ON, all segments of the display should be on as shown in the adjacent illustration.

This "segment check" will be displayed briefly, the Display will momentarily blank and then indicate zero.

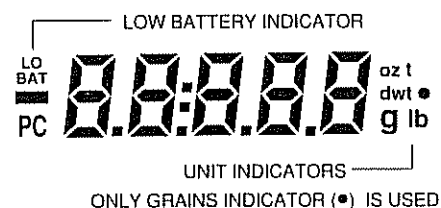

## OPERATION



**IMPORTANT!** VERIFY CALIBRATION ACCURACY PRIOR TO USE.  
PERFORM CALIBRATION PROCEDURE IF REQUIRED.

### Weighing

- With the scale ON, press  to obtain a zero reading on the Display.
- Place the material to be weighed on the platform.
- Wait until the unit indicator (●) appears before reading the displayed weight. When the unit indicator appears, the reading is stable.

### Re-zeroing

When weighing material such as powder that must be held in a container, zeroing enables the scale to automatically subtract the weight of the container. Only the net weight of the powder in the container will be displayed.

- If necessary, press  with no weight on the platform to obtain a zero reading.
- Place an empty scale pan on the platform.
- Press .

Zero will be displayed and the scale pan's weight will be stored in the scale's memory, and will automatically be subtracted from the next weighing.

- Add the powder to the scale pan. As powder is added, its net weight will be displayed.
- When the scale pan and its contents are removed from the platform, the weight of the scale pan only will be displayed as a negative number.

**NOTE:** The combined weight of the scale pan and the powder must not exceed the capacity of the scale.

The scale pan's weight will remain in memory until  is pressed again.

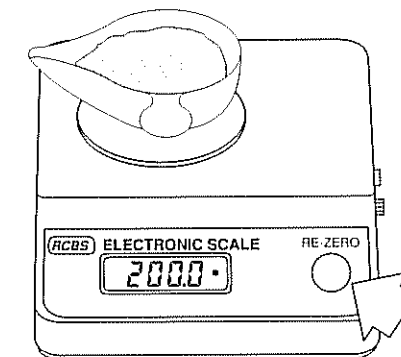
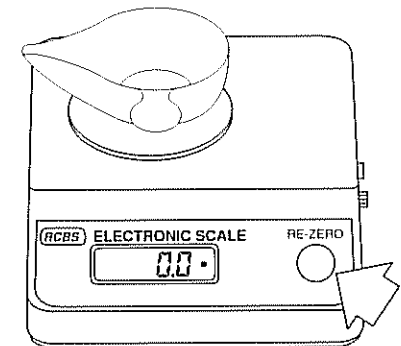

(Example)

## CALIBRATION

The scale has been calibrated before shipment, however, it should be checked before use and recalibrated if necessary. The procedure only takes a few seconds to perform and should be performed frequently to ensure accurate weighing.

Remember, a scale with an inaccurate calibration will cause an inaccurate weighing, which may exceed the maximum recommended listed load.

Calibration resets the scale's weighing range and minimizes deviation between actual and displayed weights within the scale's weighing range. Three weight values are used: zero, a weight value at the midpoint (250 grains) of the scale's specified capacity, and a weight value at the scale's capacity (500 grains).

## Checking Calibration

To check the scale's calibration, place one of the 250 grain weights (supplied) on the platform and read the displayed weight. Next place both 250 grain weights on the platform and read the displayed weight. If the readings do not fall within +/- 0.1 grain tolerance, perform the calibration procedure.

## Calibration Procedure

Before beginning this procedure, allow the scale to warm-up for a minimum of 5 minutes. Make sure the two 250 grain weights (supplied) are on hand.

The calibration button can be seen inside the hole located on the right side of the scale, closest to the front. If there is a hole plug in the hole, remove it to expose the button.

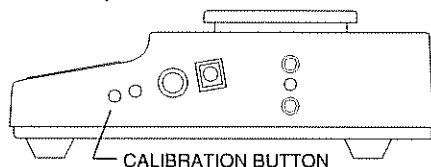

1. Make sure the scale is OFF and all weight is removed from the platform.
2. To start calibration, press and hold the calibration button while switching the scale ON. Use a long narrow object such as a small screwdriver or pencil to press the calibration button.

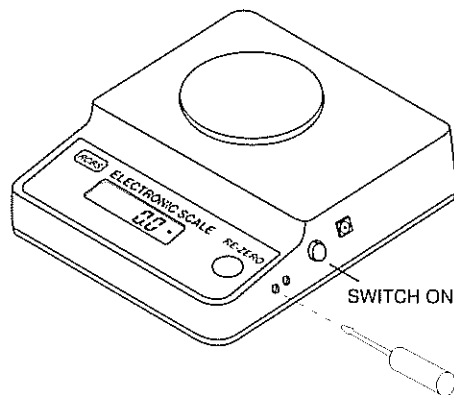

3. When the calibration button is released, "C 0" will be displayed, indicating that no weight should be on the platform.

With no weight on the platform,

press 

4. When  is released,

"-C-" will be displayed briefly, then "C 250".

DO NOT DISTURB THE SCALE WHEN "- C -" IS DISPLAYED. The scale is waiting for a stable weight reading and disturbances will result in improper calibration.

5. Place a 250 grain weight on the platform,

then press 

6. When  is released,

"-C-" will be displayed briefly, then "C 500".

7. Add the second 250 grain weight,

then press 

When  is released,

"-C-" will be displayed while the scale recalibrates itself.

DO NOT REMOVE WEIGHTS UNTIL UNIT INDICATOR (●) APPEARS. When the indicator appears, calibration is completed and the weights can be removed.

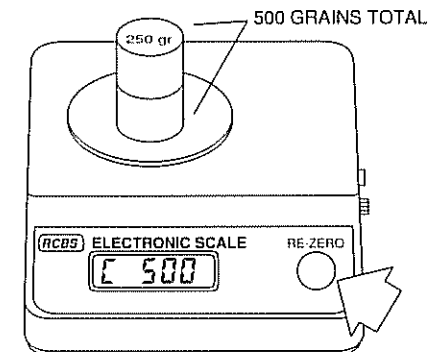
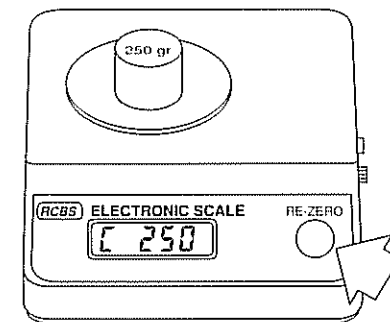
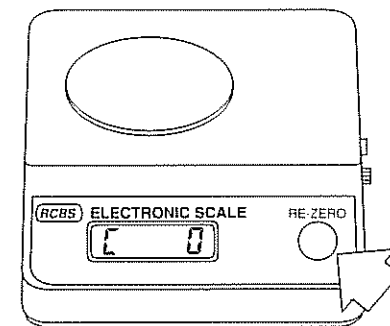

## TROUBLESHOOTING

Before assuming that your RCBS Electronic Scale is faulty, check through the following troubleshooting list. These simple corrective actions may eliminate a call to your Service Representative.

SYMPTOM	PROBABLE CAUSE	REMEDY
No Display	Power Adapter not connected.	Connect Power Adapter.
	Batteries are dead.	Replace batteries.
LO BAT Indicator	Batteries are weak.	Replace batteries.
---	Underweight Indicator	Platform is off scale. If this occurs when platform is on scale, Zero Adjustment may be needed.
Incorrect Weight Reading	Scale was not re-zeroed before weighing.	Press  with no weight on the platform, then weigh.
	Scale has not been properly calibrated.	Recalibrate correctly.
Calibration Procedure does not work	Incorrect weights being used.	Use correct weights.
	Zero adjustment may be incorrect.	See ZERO ADJUSTMENT.

### Error Messages:

Error	Description
Err 0	This indicates a hardware error causing an invalid checksum on Calibration Data. The scale may need recalibration. If the error persists after recalibration, the scale must be serviced.
Err 1	Sample being weighed exceeds the capacity of the scale. If error occurs when the sample is within scale capacity, scale may be incorrectly calibrated or may need Zero Adjustment.
Err 2	This indicates a hardware error causing an internal weight signal which is too high. Zero Adjustment may be needed. If the error persists after Zero Adjustment, the scale must be serviced.

Err 3 This indicates a hardware error causing an internal weight signal which is too low. Zero Adjustment may be needed. If the error persists after Zero Adjustment, the scale must be serviced.

Error 3 appears on the Display as "--".

Err 4 Incorrect or no calibration weight used when performing calibration procedure. Error will flash momentarily, then scale will use previous calibration data. Recalibrate correctly.

Err 5 Net weight of sample being weighed exceeds the capacity of the scale. The scale permits weighing up to 500 grains of material, after the weight of the scale pan has been zeroed. Make sure the scale pan has been zeroed before adding material (see "Re-zeroing" section). If error persists when sample is within scale capacity, scale may be incorrectly calibrated or may need Zero Adjustment.

## ZERO ADJUSTMENT

The zero setting has been adjusted before shipment. If the setting has been disturbed due to rough handling, use the following procedure to adjust the scale zero. A small screwdriver is required.

1. The scale should be turned OFF, on a level surface, and the platform must be installed.

2. The zero adjustment screw can be seen inside the hole located on the right side of the scale, closest to the ON/OFF button. If there is a hole plug in the hole, remove it to expose the adjustment screw.

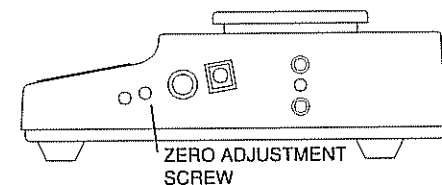

3. Turn the scale ON and wait until zero, "--", "Err 1" or "Err 2" is displayed. If "--" is displayed, proceed to step 5.

4. SLOWLY turn the screw clockwise until "--" is displayed.

5. SLOWLY turn the screw counterclockwise until numbers appear on the display.

6. Repeat steps 4 and 5 until the exact position where numbers first appear can be determined. This point must be accurately determined otherwise the scale may become erratic during operation.

7. Once this position is determined, turn the screw an additional 1/2 turn in the same counterclockwise direction.

8. Remove the screwdriver and press the RE-ZERO button.

9. Perform the calibration procedure.

## CARE AND MAINTENANCE

To keep the scale operating properly, the housing and platform should be kept clean and free from foreign material. If necessary, a cloth dampened with a mild detergent may be used. Keep calibration weights in a safe dry place.

Unplug the AC Adapter when not in use. For long term storage, remove the batteries.

## SPECIFICATIONS

Capacity (gn)	500
Readability (gn)	0.1
Precision (gn)	0.1
Linearity (gn)	±0.1
Platform Size	3" diameter
Re-zero Range	Full Capacity
Power Requirement	AC Adapter (Supplied with Scale)
Battery Operation	8 AA Alkaline Batteries (Not Supplied)
Typical Battery Life	50 Hours

## REPLACEMENT PARTS

	OHAUS PART NO.
Calibration Weight (250 grain)	77231-00
Scale Pan (Scoop)	5077-00
AC Adapters:	
100/120 V US Plug	90524-77
220/240 V EURO Plug	90524-75
240 V UK Plug	90524-79
Platform	77058-00
Antistatic Towelettes	76685-00
Instruction Manual	77236-00

## SERVICE INFORMATION

If the Troubleshooting section does not resolve or describe your problem, you will need to contact Ohaus Corporation which supplies this product to RCBS. For service, please call Ohaus Corporation toll-free at (800) 526-0659. Service hours are 8:00 a.m. to 4:00 p.m. Eastern time (Mon. - Fri.). An Ohaus Product Service Specialist will be available to help you.

**NOTE:** In New Jersey call (201) 377-9000.

## LIMITED WARRANTY

(THIS SCALE IS NOT COVERED UNDER  
RCBS' LIFETIME WARRANTY.)

Your RCBS Electronic Scale is warranted by Ohaus Corporation against defects in materials and workmanship for two (2) years from date of delivery. During the warranty period Ohaus will repair, or, at its option, replace any component(s) that proves to be defective at no charge, provided that the scale is returned (shipping charges prepaid) to Ohaus Corporation.

This warranty does not apply if the scale has been damaged by accident or misuse, exposed to radioactive or corrosive materials, has foreign material penetrating to the inside of the scale, or as a result of service or modification by other than a Service Center authorized by Ohaus. In lieu of a properly returned warranty registration card, the warranty period shall begin on the date of shipment to the authorized dealer. No other express or implied warranty is given by Ohaus Corporation. Ohaus Corporation shall not be liable for any consequential damages.





**Your Shooting Partner**

CCI,<sup>®</sup> Speer,<sup>®</sup> RCBS,<sup>®</sup> Outers<sup>®</sup> & Weaver<sup>®</sup>

We think that we make the very best reloading equipment in the world. If you agree, please tell your friends. If you disagree, tell us - we want to do something about it!  
For Customer Service call toll free: 1-800-533-5000  
Hours: Monday - Thursday 7:00 A.M. - 4:30 P.M.

**SPORTING EQUIPMENT DIVISION OF BLOUNT, INC.**  
RCBS Operation, 605 Oro Dam Blvd., Oroville, CA 95965

P/N 77236-00 R0391 Printed in USA



# ELECTRONIC SCALE

MODEL 90



Safety and Operating Instructions